

KENWOOD

KDC-4009

KDC-S3009

KDC-S2009

CD-RECEIVER

INSTRUCTION MANUAL

AMPLI-TUNER-LECTEUR DE CD

MODE D'EMPLOI

REPRODUCTOR DE DISCOS COMPACTOS RECEPTOR DE FM/AM

MANUAL DE INSTRUCCIONES

KENWOOD CORPORATION

Take the time to read through this instruction manual.

Familiarity with installation and operation procedures will help you obtain the best performance from your new CD-receiver.

For your records

Record the serial number, found on the back of the unit, in the spaces designated on the warranty card, and in the space provided below. Refer to the model and serial numbers whenever you call upon your KENWOOD dealer for information or service on the product.

Model KDC-4009/S3009/S2009 Serial number _____

©B64-1055-00 (KW)



Contents

Before use

Warning.....	3
Safety precautions.....	5
Handling Compact discs.....	7

Buttons and Display

Basic operations.....	8
Tuner features.....	8
CD player features.....	9
Disc changer control features.....	9
Other features.....	10
Remote.....	10

Basic operations

Power.....	11
Volume.....	11
Attenuator.....	11
Loudness.....	11

Basic Operations of Remote Control.....12

Tuner features

Tuning.....	13
Station Preset Memory.....	14
Auto Memory Entry.....	14
Clean Reception System Circuit (CRSC).....	14
Direct Access Tuning.....	14

CD player features

Playing CDs.....	15
Switching Display for CDs.....	15
Fast Forwarding and Reversing Disc Play.....	15
Track Search.....	15
Direct Track Search.....	16
Track Repeat.....	16
Track Scan.....	16
Random Play.....	16

Disc changer control features

Playing Discs Using a Disc Changer.....	17
Switching Display for Discs.....	17
Fast Forwarding and Reversing Disc Play.....	17

Track Search.....	18
Disc search.....	18
Direct Track Search.....	18
Direct Disc Search.....	19
Track / Disc Repeat.....	19
Track Scan.....	19
Disc Scan.....	20
Random Play.....	20
Magazine Random Play.....	20
Presetting Disc Names.....	21

Other features

Audio Control Setting.....	22
Clock Display.....	22
Adjusting Time.....	22
Selectable Illumination.....	22
Disabled System Indicator (DSI).....	23
Theft Deterrent Faceplate.....	23

Installation

Accessories.....	24
Installation Procedure.....	24
Connecting Wires to Terminals.....	25
Installation.....	26

Troubleshooting Guide.....29

Specifications.....32

▲ Warning



Dear Customer:

Selecting fine audio equipment such as the unit you've just purchased is only the start of your musical enjoyment. Now it's time to consider how you can maximize the fun and excitement your equipment offers. This manufacturer and the Electronic Industries Association's Consumer Electronics Group want you to get the most out of your equipment by playing it at a safe level. One that lets the sound come through loud and clear without annoying blaring or distortion — and, most importantly, without affecting your sensitive hearing.

Sound can be deceiving. Over time your hearing "comfort level" adapts to higher volumes of sound. So what sounds "normal" can actually be loud and harmful to your hearing. Guard against this by setting your equipment at a safe level **BEFORE** your hearing adapts.

To establish a safe level:

- Start your volume control at a low setting.
- Slowly increase the sound until you can hear it comfortably and clearly, and without distortion.

Once you have established a comfortable sound level:

- Set the dial and leave it there.

Taking a minute to do this now will help to prevent hearing damage or loss in the future. After all, we want you listening for a lifetime.

We Want You Listening For A Lifetime

Used wisely, your new sound equipment will provide a lifetime of fun and enjoyment. Since hearing damage from loud noise is often undetectable until it is too late, this manufacturer and the Electronic Industries Association's Consumer Electronics Group recommend you avoid prolonged exposure to excessive noise. This list of sound levels is included for your protection.

Decible

Level Example

30	Quiet library, soft whispers
40	Living room, refrigerator, bedroom away from traffic
50	Light traffic, normal conversation, quiet office
60	Air conditioner at 20 feet, sewing machine
70	Vacuum cleaner, hair dryer, noisy restaurant
80	Average city traffic, garbage disposals, alarm clock at two feet.

THE FOLLOWING NOISES CAN BE DANGEROUS UNDER CONSTANT EXPOSURE

90	Subway, motorcycle, truck traffic, lawn mower
100	Garbage truck, chain saw, pneumatic drill
120	Rock band concert in front of speakers, thunderclap
140	Gunshot blast, jet plane
180	Rocket launching pad

Information courtesy of the Deafness Research Foundation.



▲ Warning**▲ CAUTION**

Use of controls or adjustments or performance of procedures other than those specified herein may result in hazardous radiation exposure.

In compliance with Federal Regulations, following are reproductions of labels on, or inside the product relating to laser product safety.

KENWOOD CORPORATION
2967-3, ISHIKAWA-CHO,
HACHIOJI-SHI
TOKYO, JAPAN

KENWOOD CORP. CERTIFIES THIS EQUIPMENT
CONFORMS TO DHHS REGULATIONS NO.21 CFR
1040. 10, CHAPTER I, SUBCHAPTER J.

Location : Bottom Panel

FCC WARNING

This equipment may generate or use radio frequency energy. Changes or modifications to this equipment may cause harmful interference unless the modifications are expressly approved in the instruction manual. The user could lose the authority to operate this equipment if an unauthorized change or modification is made.

NOTE

This equipment has been tested and found to comply with the limits for a Class B digital device, pursuant to Part 15 of the FCC Rules. These limits are designed to provide reasonable protection against harmful interference in a residential installation. This equipment may cause harmful interference to radio communications, if it is not installed and used in accordance with the instructions. However, there is no guarantee that interference will not occur in a particular installation. If this equipment does cause harmful interference to radio or television reception, which can be determined by turning the equipment off and on, the user is encouraged to try to correct the interference by one or more of the following measures:

- Reorient or relocate the receiving antenna.
- Increase the separation between the equipment and receiver.
- Connect the equipment into an outlet on a circuit different from that to which the receiver is connected.
- Consult the dealer or an experienced radio/TV technician for help.

NOTE

This Class B digital apparatus meets all requirements of the Canadian interference-Causing Equipment Regulations.

Safety precautions

▲WARNING

To prevent injury or fire, take the following precautions:

- Insert the unit all the way in until it is fully locked in place. Otherwise it may fall out of place when jolted.
- When extending the ignition, battery, or ground wires, make sure to use automotive-grade wires or other wires with a 0.75mm² (AWG 18) or more to prevent wire deterioration and damage to the wire coating.
- To prevent a short circuit, never put or leave any metallic objects (such as coins or metal tools) inside the unit.
- If the unit starts to emit smoke or strange smells, turn off the power immediately and consult your Kenwood dealer.
- Be careful not to drop the unit or subject it to strong shock.
The unit may break or crack because it contains glass parts.
- Do not touch the liquid crystal fluid if the LCD is damaged or broken due to shock. The liquid crystal fluid may be dangerous to your health or even fatal.
If the liquid crystal fluid from the LCD contacts your body or clothing, wash it off with soap immediately.

▲CAUTION

To prevent damage to the machine, take the following precautions:

- Make sure to ground the unit to a negative 12V DC power supply.
- Do not open the top or bottom covers of the unit.
- Do not install the unit in a spot exposed to direct sunlight or excessive heat or humidity. Also avoid places with too much dust or the possibility of water splashing.
- When replacing a fuse, only use a new one with the prescribed rating. Using a fuse with the wrong rating may cause your unit to malfunction.
- To prevent a short circuit when replacing a fuse, first disconnect the wiring harness.
- Do not use your own screws. Use only the screws provided. If you use the wrong screws, you could damage the unit.

For KDC-4009/S3009

- Do not set the removed faceplate or the faceplate case in areas exposed to direct sunlight, excessive heat, or humidity. Also avoid places with too much dust or the possibility of water splashing.
- Do not subject the faceplate to excessive shock, as it is a piece of precision equipment.
- To prevent deterioration, do not touch the terminals of the unit or faceplate with your fingers.

IMPORTANT INFORMATION

For KDC-4009

You cannot connect the unit directly to the following CD automatic changers. If you want to use older changers with the unit, follow the directions below according to the type of changer you own:

• **KDC-C200 / KDC-C300 / KDC-C400**

Use the extension cable and the control box attached to the CD changer, and the optional CA-DS100 converter cord.

• **KDC-C301 / KDC-C600 / KDC-C800 / KDC-C601 / KDC-C401**

Use the extension cable attached to the CD changer, and the optional CA-DS100 converter cord.

• **KDC-C100 / KDC-C302 / C205 / C705 / non-Kenwood CD changers**

Cannot be used with this model.

▲CAUTION

You can damage both your unit and the CD changer if you connect them incorrectly.

Safety precautions

NOTE

- If you experience problems during installation, consult your Kenwood dealer.
- If the unit doesn't seem to be working right, try pressing the reset button first. If that does not fix the problem, consult your Kenwood dealer.

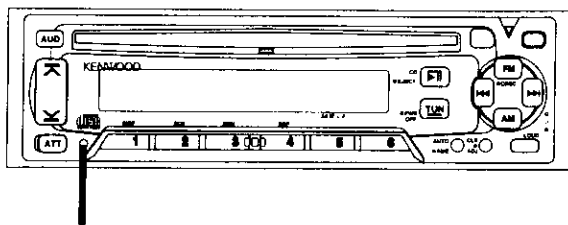

Reset button

Cleaning the Unit

If the front panel gets dirty, turn off the power and wipe the panel with a dry silicon cloth or soft cloth.

CAUTION

Do not wipe the panel with a hard cloth or a cloth dampened by volatile solvents such as paint thinner and alcohol. They can scratch the surface of the panel and/or cause the indicator letters to peel off.

Cleaning the Faceplate Terminals

(For KDC-4009/S3009)

If the terminals on the unit or faceplate get dirty, wipe them with a dry, soft cloth.

Cleaning the CD Slot

As dust tends to accumulate in the CD slot, clean it every once in a while. Your CDs can get scratched if you put them in a dusty CD slot.

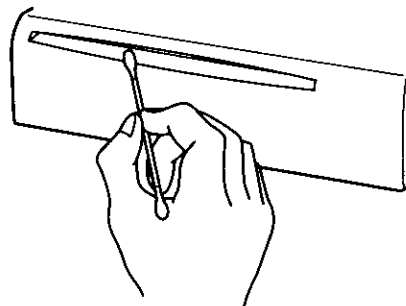

Lens Fogging

Right after you turn on the car heater in cold weather, dew or condensation may form on the lens in the CD player of the unit. Called lens fogging, CDs may be impossible to play. In such a situation, remove the disc and wait for the condensation to evaporate. If the unit still does not operate normally after a while, consult your Kenwood dealer.

Handling Compact discs

Playing a CD that is dirty, scratched or warped can cause the sound to skip and the unit to operate incorrectly, resulting in worsened sound quality. Take the following precautions to prevent your CDs from getting scratched or damaged.

Handling CDs

- Do not touch the recorded side of the CD (the side opposite the label) when holding it.

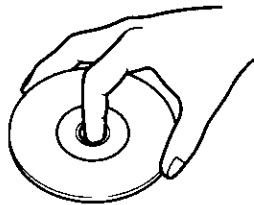

- Do not stick tape on either side of the CD.

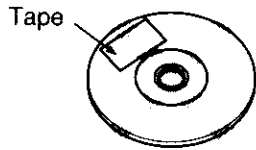

Storing CDs

- Do not store CDs in areas exposed to direct sunlight (such as a car seat or the dashboard) or other hot places.
- Remove CDs from the unit when not listening to them for a while, and put them back in their cases. Do not pile up CDs that are removed from their cases or prop them against something.

Cleaning CDs

If a CD has gotten dirty, wipe it off gently using a commercially available cleaning cloth or a soft cotton cloth, starting from the center of the disc and moving outward. Do not clean CDs with conventional record cleaners, anti-static formulas, or chemicals such as paint thinner or benzene.

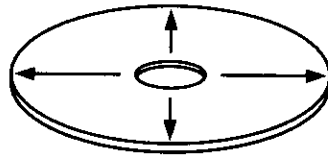

Checking New CDs for Burrs

When playing a new CD for the first time, check that there are not any burrs stuck to the perimeter of the disc or in the central hole. CDs with burrs stuck on them may not load properly or may skip while playing. Remove burrs using a ballpoint pen or a similar utensil.

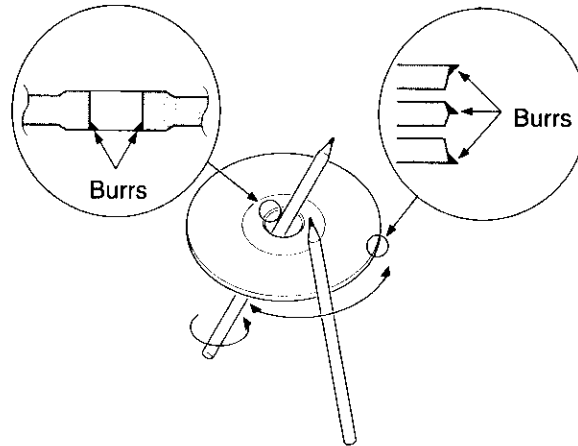

Do Not Load CD Accessories

Do not use commercially available CD accessories that can be loaded into the CD slot, such as stabilizers, protective sheets, or CD cleaning discs, since they can cause the unit to malfunction.

Removing the CD

Only remove the CD from the machine in a horizontal direction, holding it flat. You may damage the surface of the CD if you try pulling it down as it ejects.

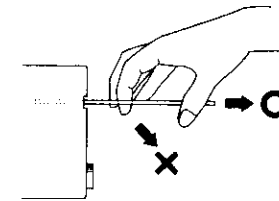

CAUTION

Do Not Load 3-in. CDs in the CD slot

If you try to load a 3 in. CD with its adapter into the unit, the adapter might separate from the CD and damage the unit.

Do Not Use Special Shape CDs

- Be sure to use round shape CDs only for this unit and do not use any special shape CDs. Use of special shape CDs may cause the unit to malfunction.

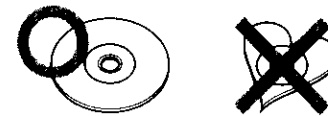

- Be sure to use CDs with disc mark  only for this unit.

Buttons and Display

English

Basic operations

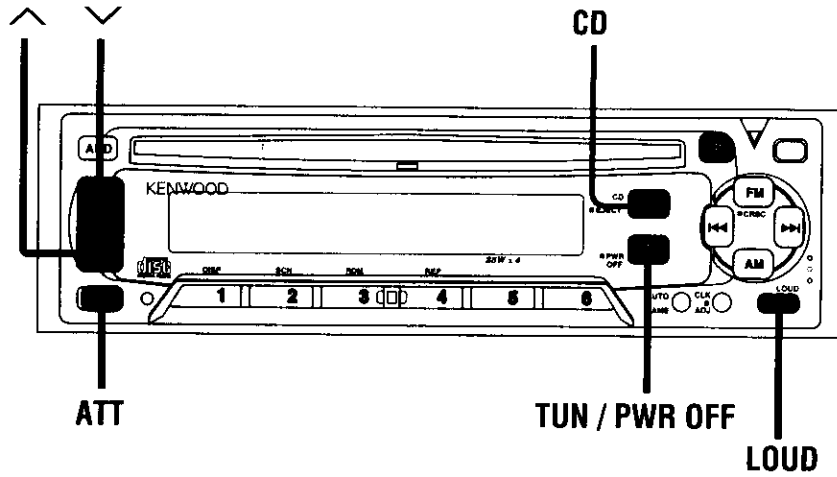

Tuner features

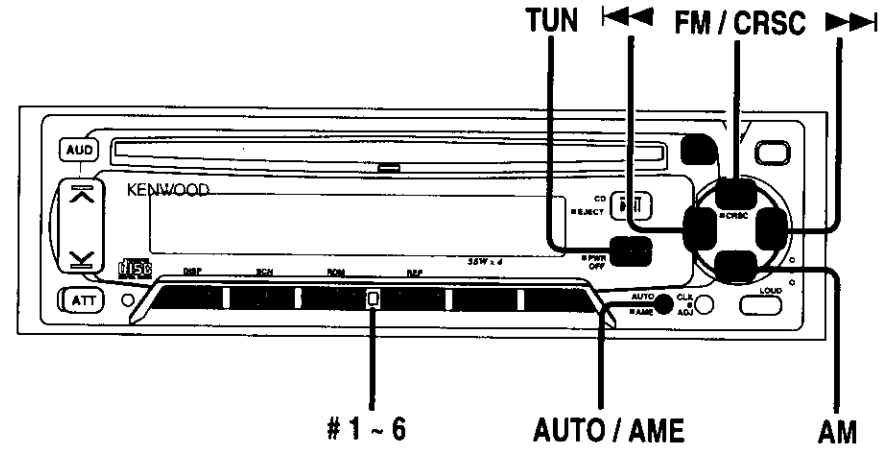

LOUD indicator



ATT indicator

ST indicator

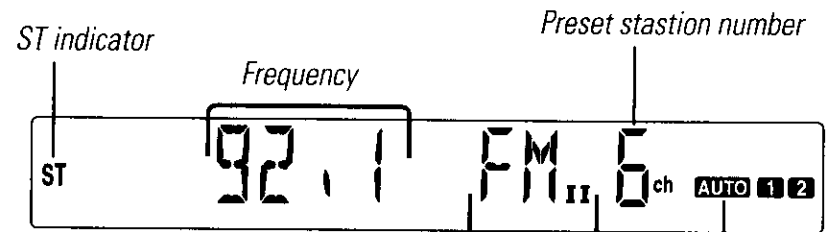

Band display

AUTO indicator

CD player features

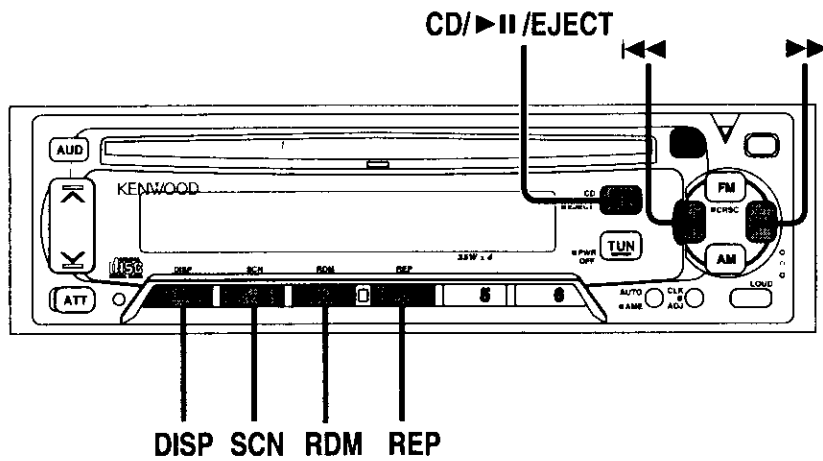

Disc changer control features

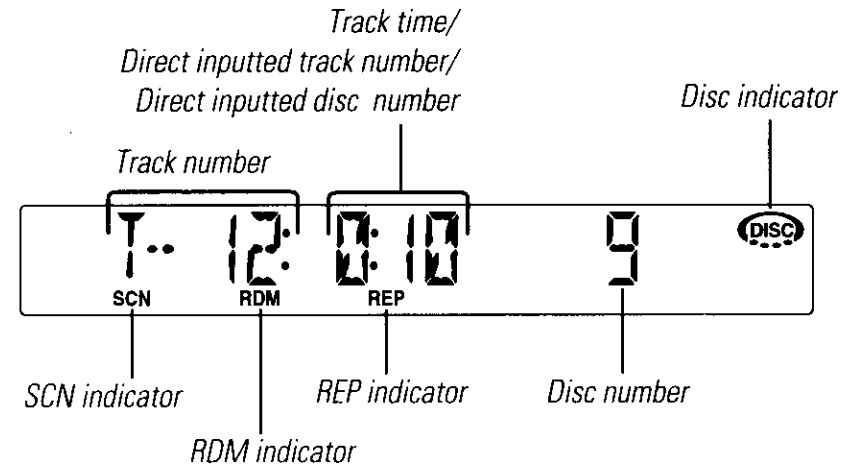
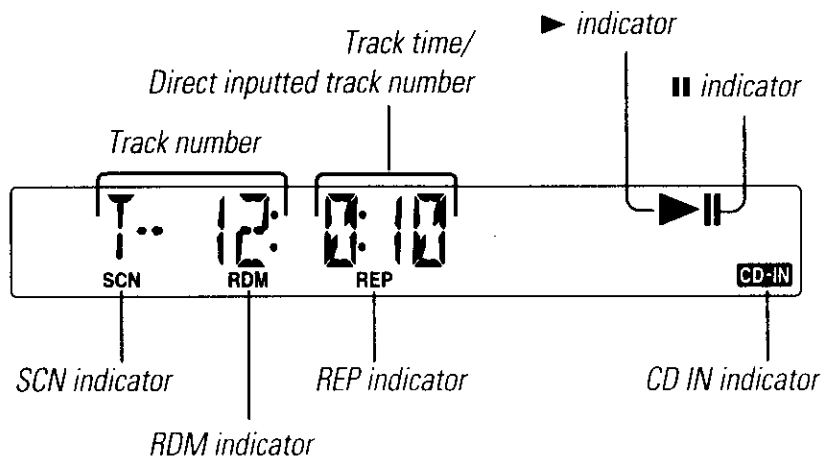
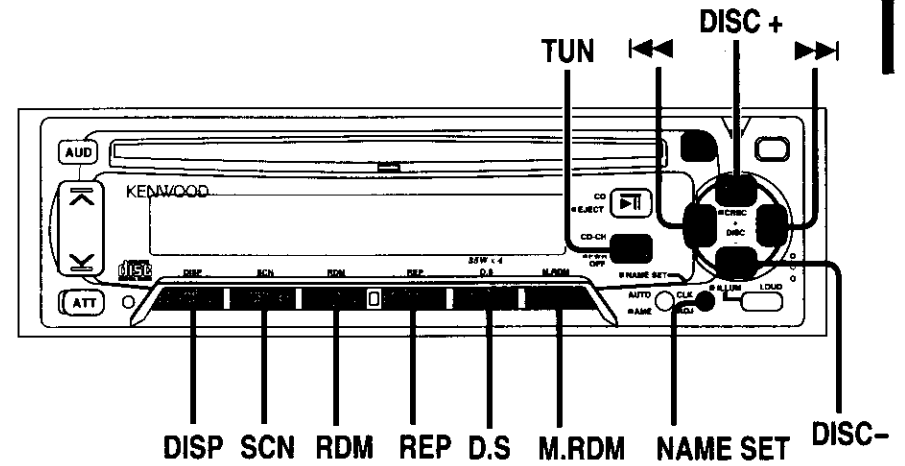

Buttons and Display

Other features

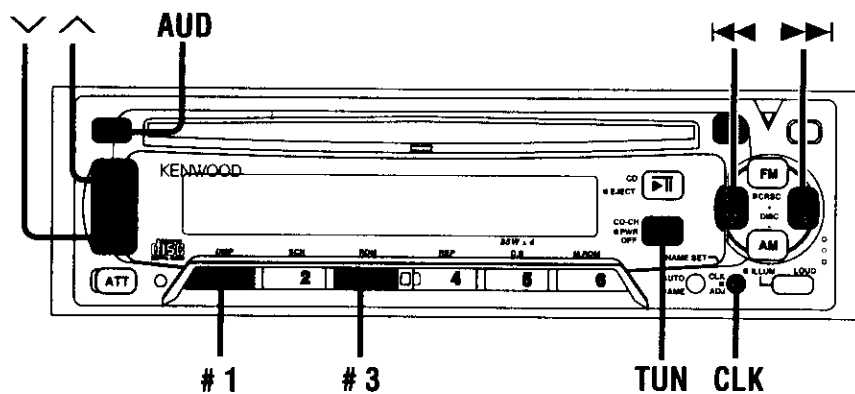

Clock display

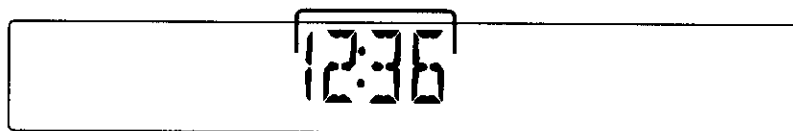

Remote

Optional for the KDC-4009

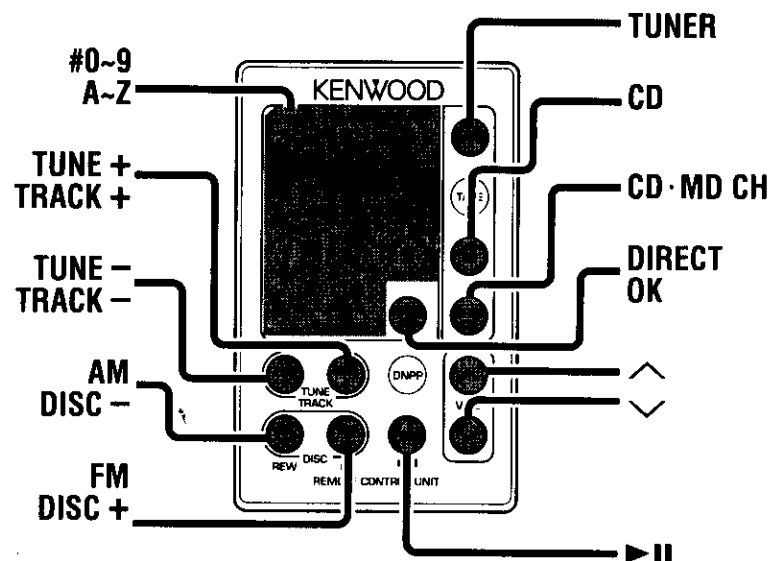

Basic operations (See page 8)

Power

Turning on the power:

Press either the CD or TUN button.

NOTE

Turn the power on before completing the following procedures.

Turning off the power:

Press the PWR OFF button for at least one second.

Volume

Increasing Volume:

Press the \wedge button to turn up the volume.

Decreasing Volume:

Press the \vee button to turn down the volume.

Attenuator

This function allows you to turn down the volume quickly.

Turning Attenuator On/Off:

Press the ATT button to switch the attenuator on and off.

When the attenuator is on, the ATT indicator blinks.

When the attenuator is off, the volume returns to the original level.

NOTE

Turning the volume all the way down deactivates the attenuator function.

Loudness

This function amplifies low and high tones when the volume is turned down.

The LOUD indicator lights up when the loudness function is on.

Turning Loudness On/Off:

Press the LOUD button to switch the loudness on and off.

Basic operations of remote control *(See page 10) Optional for the KDC-4009*

▲CAUTION

Do not set the remote on hot places such as above the dashboard.

Replacing the Lithium Battery:

Use one lithium battery (CR2025).

Remove the case following the instructions as illustrated.

To open

- ① Keep on slide
- ② Pull out.

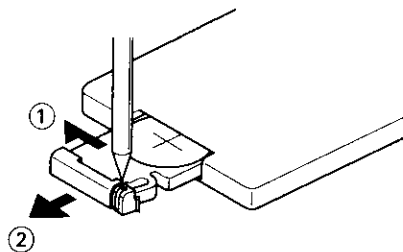

Insert the battery with the + and - poles aligned properly, following the illustration inside the case.

▲WARNING

Store unused lithium batteries out of the reach of children. Contact a doctor immediately if the battery is accidentally swallowed.

All Modes

- **VOL. buttons**
Press the \wedge button to turn the volume up.
Press the \vee button to turn the volume down.
- **TUNER button**
Selects the tuner mode. Pressing this button again selects the standby mode.
- **CD button**
Selects the CD mode.
- **CD•MD CH button**
Selects the disc changer mode.

Tuner Mode

- **Number buttons**
Press buttons #1-6 to recall preset stations.
During direct access tuning, use these buttons to input the frequency of the station.
- **TUNE buttons**
Press the TUNE $-$ button to decrease the frequency.
Press the TUNE $+$ button to increase the frequency.
- **AM/FM button**
Press the AM button to select the AM band.
Press the FM button to select and switch between FM1, FM2, and FM3 bands.
- **DIRECT button**
Selects the direct access tuning mode, used to input frequencies directly. Press this button again to cancel the mode while it is operating.

CD Mode

- **Number buttons**
Used to specify the track number used in direct track searches.
- **TRACK buttons**
Press the TRACK $-$ button to search through the tracks backward.
Press the TRACK $+$ button to search through the tracks forward.
- **▶|| button**
When a disc is playing, this button pauses the play.
Press the same button again to start play again.

Disc Changer Mode

- **Number / letter entry buttons**
Used to specify the track (disc) number used in direct track (disc) searches.
Use to enter letters during disc name preset.
- **TRACK buttons**
Press the TRACK- button to search through the tracks backward.
Press the TRACK+ button to search through the tracks forward.
Use to move the cursor while entering disc name.
- **DISC buttons**
Press the DISC- button to search through the discs backward.
Press the DISC+ button to search through the discs forward.
Select numbers and symbols while entering disc name.
- **▶|| button**
When a disc is playing, this button pauses the play.
Press the same button again to start play again.
- **OK button**
Stores letters that have been entered during disc name input and ends enter mode.

Tuner features (See page 8)

Tuning

You can choose from three tuning modes: auto seek, preset station seek, and manual. The "Auto1" indicator lights up when auto seek tuning is selected, and the "Auto2" indicator lights when preset station seek tuning is selected.

Selecting Tuning Mode:

Press the AUTO button.

Each time you press the AUTO button, the mode switches as follows.

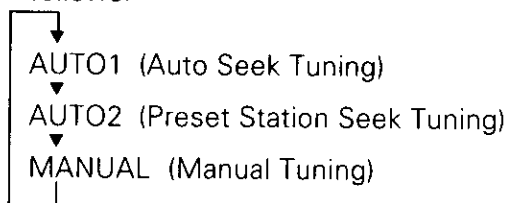

Tuning:

- 1 Press the TUN button to turn the radio on.
- 2 Press either the FM or AM button to select the band.
Each time you press the FM button, the band switches between the FM1, FM2 and FM3 (which are used for groups of preset stations).
Press the AM button to select the AM band.
- 3
 - Auto Seek Tuning
Press the ►► button to seek higher frequencies.
Press the ◀◀ button to seek lower frequencies.
 - Preset station seek tuning
Press the ►► button to move to the next preset station (i.e., the one with the next highest number), and the ◀◀ button to move to the last preset station (i.e., the one with the next lowest number).
 - Manual Tuning
Press the ►► button to increase the frequency by one step.
Press the ◀◀ button to decrease the frequency by one step.

NOTE

The ST indicator lights up when stereo broadcasts are being received.

Tuner features *(See page 8)*

Station Preset Memory

Store the frequency of a station. You can then recall that station with a single touch of a button.

- 1 Select the band/station that you want to have stored.
- 2 Press the button (#1-6) that you want to use for the station, for at least two seconds.
The button number blinks once in the display to indicate that the data has been stored.

Recalling a Preset Station:

Press the preset station button (#1-6) for the desired station. The number of the recalled station is displayed.

NOTE

You can store six stations in each of the FM1, FM2, FM3, and AM bands.

Auto Memory Entry

You can automatically store all the receivable frequencies in the band currently being listened to, and then recall them with the touch of a button later. This function is especially useful when you are travelling and do not know what stations are available. Up to six frequencies can be stored this way.

- 1 Select the band for which you want to store stations.
- 2 Press the AME button for at least two seconds to start auto memory entry.
The numbers of the preset station buttons are shown in order. When all the stations in a certain band are stored in the preset memory, the auto memory entry stops. The tuner then plays the last station received.

Recalling a Preset Station:

Press the preset station button (#1-6) for the desired station. The number of the recalled station is displayed.

Clean Reception System Circuit (CRSC)

Temporarily have reception switched from stereo to mono to reduce multi-path noise when listening to the FM station. The factory default for this function is ON.

Turning CRSC On/Off:

Press the CRSC button for at least one second to turn the function on/off. "CRSC ON" is displayed when CRSC is on.

NOTE

Strong electrical fields (such as from power lines) may cause unstable sound quality when CRSC is turned on. In such a situation, turn it off.

Function of Remote (See page 10)

Direct Access Tuning

When you already know the frequency of the station that you want to listen to, you can enter it directly for quick access. (Function of remote control)

- 1 Select the band by pressing the FM or AM button.
- 2 Press the DIRECT button.
In the display, "----" blinks for 10 seconds.
If you make no input in the 10-second period, direct access tuning is automatically cancelled.
- 3 Enter the frequency of the desired station whilst the display is blinking.
If you want to listen to an FM station at 92.1 MHz, for example, press 0, 9, 2, and 1.
If you want to listen to an AM station at 810 kHz, for example, press 0, 8, 1, and 0.

NOTE

- When a frequency which cannot be received is input, this frequency is not verified and operation returns to the original frequency input mode.
- FM frequencies can only be input in 0.1 MHz steps, and not in 0.01 steps.

Canceling Direct Access Tuning:

Press the DIRECT button again.

CD player features (See page 9)

Playing CDs

Playing CDs:

If no CDs are inserted, insert one in the slot with the label facing up.

If a CD is already inserted, press the CD button.

The CD-IN indicator lights up when a CD has been inserted.

The ► indicator lights up when a CD is being played.

Pausing and Restarting CD Play:

Press the ►|| button to make the disc pause.

The || indicator lights up.

Press the same button again to start play again.

Stopping and Ejecting CDs:

Press the EJECT button for at least one second.

The CD stops playing and ejects from the slot.

▲CAUTION

- Do not attempt to insert a CD into the slot if another one is already there.
- The unit can only play 5 in. CDs. If you insert a 3 in. CD, it will get stuck inside and can cause the unit to malfunction.

NOTE

When you load a CD and eject it right away, the next time you try to insert the CD may not load. In such a situation, take the CD out for a moment and then reinsert it.

Switching Display for CDs

Switch the display that appears while discs are playing.

Switching Display for CDs:

Each time you press the DISP button, the display during CD play switches as follows:

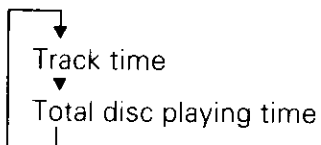

Fast Forwarding and Reversing Disc Play

Fast Forwarding Disc Play:

Hold down on the ►►I button.

Release your finger to play the disc at that point.

Reversing Disc Play:

Hold down on the I◄◄ button.

Release your finger to play the disc at the point.

Track Search

Search forward or backward through the tracks on the disc until you reach the one that you want to listen to.

Making a Reverse Track Search:

Press the I◄◄ button to display the desired track number.

Press once to search back to the beginning of the current track, twice to search back to the beginning of the previous track, and so forth.

Play starts at the beginning of the displayed track number.

Making a Forward Track Search:

Press the ►►I button to display the desired track number.

Press once to fast forward to the next track, twice to fast forward to the track after that, and so forth.

Play starts at the beginning of the displayed track number.

CD player features (See page 9)

Function of Remote (See page 10)

Direct Track Search

Using the remote, directly input the track number that you want to listen to.

- 1 Using the number buttons on the remote, input the number of the track that you want to listen to.
The selected track number will blink in the display for 10 seconds.
If you make no further input in the 10-second period, the number entry mode will automatically be canceled.
- 2 Press either the TRACK+ or TRACK- button while the track number is blinking.
The track starts playing.

Canceling Direct Track Search While It Is Operating:

Press the ►|| button.

NOTE

You cannot use the direct track search function while doing track scans or using random play.

Track Repeat

Repeat playing the track currently being listened to.

Turning Repeat Play On/Off:

Press the REP button to switch repeat play on and off.
The REP indicator lights up when repeat play is turned on.
The track number currently being heard blinks in the display.

NOTE

Repeat play is canceled when you stop playing the disc.

Track Scan

Successively play the beginning of each track on a disc until you find the track that you want to listen to.

Turning Track Scan On/Off:

Press the SCN button to switch track scan on and off.
The SCN indicator lights up when track scan is turned on.
The first 10 seconds of each track will be played, in order.
The track number currently being heard blinks in the display.

Stopping to Listen to the Track Being Scanned:

Press the ►|| or SCN button again to stop the scan and keep on listening to a track normally.

NOTE

- Track scan is canceled when you stop playing a disc.
- Track scan only scans each track on a disc once.

Random Play

Play all the tracks on the current disc in random order.

- 1 Press the RDM button to switch random play on and off.
The RDM indicator lights up when random play is turned on.
The track number will change over and over in the display as the next track is being selected.
When the track has been selected, play will begin.
The selected track number blinks in the display as it is being played.
- 2 To change the track being heard, press the ►►| button.
Another track will be selected and played.

NOTE

Random play is canceled when you stop playing a disc.

Disc changer control features (See page 9) Optional for the KDC-4009

When the disc changer with the old/new selection switch is connected, set the switch to "O" (old) position to operate the disc changer mode.

Playing Discs Using a Disc Changer

Playing Discs:

Press the TUN button repeatedly to select the disc changer mode.
"DISC" is displayed when the unit is in the disc changer mode. The disc indicator lights up during disc changer mode.
When one disc has finished playing its last track, the next disc in the changer will start playing. When the last disc in the changer has finished, the player will return to the first disc and start playing it.
Disc #10 is displayed as "0".

Switching Display for Discs

Switch the display that appears whilst discs are playing.

Switching Display for Discs:

Each time you press the DISP button, the display during disc play switches as follows.

↓
Track time
↓
Total disc playing time (CD only)
↓
Disc name
↓
Disc title (MD only)
↓
Track title (MD only)

NOTE

- You can give names to discs through the presetting disc name function (see p. 21).
- If you try to display the name of a disc that does not have one, "NO NAME" is displayed instead.

Fast Forwarding and Reversing Disc Play

Fast Forwarding Disc Play:

Hold down on the ►► button.
Release your finger to play the disc at that point.

Reversing Disc Play:

Hold down on the ◀◀ button.
Release your finger to play the disc at the point.

NOTE

You cannot use reverse play between tracks when listening to an MD on the MD changer. Instead, the reverse play function is canceled when it reaches the beginning of a track, at which point normal play will automatically resume.

Disc changer control features *(See page 9) Optional for the KDC-4009*

Track Search

Search forward or backward through the tracks on the disc until you reach the one that you want to listen to.

Making a Reverse Track Search:

Press the ◀◀ button to display the desired track number. Press once to search back to the beginning of the current track, twice to search back to the beginning of the previous track, and so forth. Play starts at the beginning of the displayed track number.

NOTE

Pressing the ◀◀ button while listening to track 1 will only search back to the beginning of that track. The reverse search is not "recycled" to the last track on the disc.

Making a Forward Track Search:

Press the ▶▶ button to display the desired track number. Press once to fast forward to the next track, twice to fast forward to the track after that, and so forth. Play starts at the beginning of the displayed track number.

NOTE

You cannot make a forward track search when listening to the last track on a disc.

Disc Search

Search forward or backward through the discs in a disc changer.

Making a Reverse Disc Search:

Press the DISC — button to display the desired disc number. Each time the button is pressed, the displayed disc number decreases by one. Play starts at the beginning of the displayed disc.

Making a Forward Disc Search:

Press the DISC + button to display the desired disc number. Each time the button is pressed, the displayed disc number increases by one. Play starts at the beginning of the displayed disc.

NOTE

"LOAD" is displayed when discs are being exchanged on the disc changer.

Function of Remote (See page 10)

Direct Track Search

Using the remote, directly input the track number that you want to listen to.

- 1 Using the number buttons on the remote, input the number of the track that you want to listen to. The selected track number will blink in the display for 10 seconds. If you make no further input in the 10-second period, the number entry mode will automatically be canceled.
- 2 Press either the TRACK+ or TRACK— button while the track number is blinking. The track starts playing.

Canceling Direct Track Search While It Is Operating:

Press the ▶|| button.

NOTE

You cannot use the direct track search function while doing track or disc scans or using random or magazine-random play.

Direct Disc Search

Using the remote, directly input the disc number that you want to listen to.

- 1 Using the number buttons on the remote, input the number of the disc that you want to listen to.
The selected disc number will blink in the display for 10 seconds.
If you make no further input in the 10-second period, the number entry mode will automatically be canceled.

NOTE

- Input "0" to select disc 10.
 - If you input more than two numbers all at once, a search will be made only of the last number input.
- 2 Press either the DISC+ or DISC- button while the number inputted is blinking.
The disc starts playing.

Canceling Direct Disc Search While It Is Operating:

Press the ►|| button.

Track / Disc Repeat

Repeat playing the track or the disc currently being listened to.

Turning Repeat Play On/Off:

Press the REP button to switch repeat track/disc play on and off as follows:

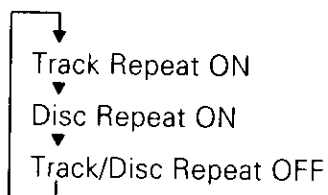

The REP indicator lights up when repeat play is turned on.
The track number blinks in the display when track repeat is on.
The disc number blinks in the display when disc repeat is on.

NOTE

Repeat play is canceled when you stop playing the disc.

Track Scan

Successively play the beginning of each track on a disc until you find the track that you want to listen to.

Turning Track Scan On/Off:

Press the SCN button to switch track scan on and off.
The SCN indicator lights up when track scan is turned on.
The first 10 seconds of each track will be played, in order.
The track number currently being heard blinks in the display.

Stopping to Listen to the Track Being Scanned:

Press the SCN button again to stop the scan and keep on listening to a track normally.

NOTE

- Track scan is canceled when you stop playing a disc.
- Track scan only scans each track on a disc once.

Disc changer control features *(See page 9) Optional for the KDC-4009*

Disc Scan

Successively play the beginning of each disc on a changer until you find the one that you want to listen to.

Turning Disc Scan On/Off:

Press the D.S button to switch disc scan on and off.
The SCN indicator lights up when disc scan is turned on.
The first 10 seconds of each disc will be played, in the order they are loaded on the changer.
The disc number currently being heard blinks in the display.

Stopping to Listen to the Disc Being Scanned:

Press the D.S button again to stop the scan and keep on listening to the disc normally.

NOTE

- Disc scan is canceled when you stop playing a disc.
- Disc scan only scans each disc on the changer once.
- "LOAD" is displayed when discs are being exchanged on the disc changer.

Random Play

Play all the tracks on the current disc in random order.

- 1 Press the RDM button to switch random play on and off.
The RDM indicator lights up when random play is turned on.
The track number will change over and over in the display as the next track is being selected.
When the track has been selected, play will begin.
The selected track number blinks in the display as it is being played.

NOTE

When all the tracks on a certain disc have been played using random play, the next disc on the changer will start playing using the same function.

- 2 To change the track being heard, press the ►►| button.
Another track will be selected and played.

NOTE

Random play is canceled when you stop playing a disc.

Magazine Random Play

Play the tracks on all the discs in the disc changer in random order.

- 1 Press the M.RDM button to switch magazine random play on and off.
The RDM indicator lights up when magazine random play is turned on.
The disc and track numbers will change over and over in the display as the next track is being selected.
When the disc/track has been selected, play will begin.
The selected disc number blinks in the display as it is being played.

NOTE

This function is not available with the following models:
KDC-C200/C300/C400/C301/C401

- 2 To change the track being heard, press the ►►| button.
Another disc/track will be selected and played.

NOTE

- Magazine random play is canceled when you stop playing a disc.
- The time needed for random selection depends on the number of discs loaded in the disc magazine.

Presetting Disc Names

Store the names of discs to be displayed when played.

- 1 Play the disc whose name you want to preset.

NOTE

- This function is not available for disc changers that do not feature the Disc Name Preset function.
- This procedure is not to be used to store the disc and track titles for MDs that you record.

- 2 Press the NAME SET button for at least two seconds. "NAME SET" is displayed and the disc name preset mode is entered.
The cursor blinks in the position where character input can be made.

- 3 Press either the ◀◀ or ▶▶ button to move the cursor to the desired position.
The ◀◀ button moves the cursor to the left, and the ▶▶ button to the right.
You can also move the cursor left or right by pressing the TRACK+ or TRACK- buttons, respectively, on the remote control.

- 4 Press the DISC+ or DISC- button to display the desired character.
Besides the alphabet (capital letters only) and numbers, you can choose the following characters: /, +, -, *, =, <, > and |, |.

NOTE Direct Input *Function of Remote (See page 10)*

If the disc changers that were manufactured and sold after 1997 (except for KDC-C560) are connected, you can directly input letters using the number/letter entry buttons.

Example: Use the following table to enter the name "DANCE".

Character	Button to press	# Times pressed
"D"	#3	1
"A"	#2	1
"N"	#6	2
"C"	#2	3
"E"	#3	2

- 5 Continue steps 3 and 4 until all the characters are chosen for the name.

NOTE

You can enter up to eight characters for each name.

- 6 Press either the NAME SET button on the main unit or the OK button on the remote.
The disc name is stored and the disc name preset mode is canceled.
If you make no entry in a 10-second period, the name will be stored with the characters input so far.

NOTE

- The number of discs whose names can be stored will differ depending on the disc changer that is connected. Please see your disc changer manual for details.
- Discs are identified by their total length and number of tracks. If another disc happens to have the same specifications as one that you have already stored a name for, the name will be displayed for it, too.
- If you want to change the name of a disc, repeat steps 1 and 2 to display the name, and then repeat steps 3 and 4 to input the changes.
- Pressing the reset button does not erase the disc names stored in a disc changer.

Other features (See page 10)

Audio Control Setting

Adjust various parameters of sound quality.

- 1 Press the AUD button to enter the control mode.
Each time the AUD button is pressed, the adjustment mode display changes as follows:

▶ Bass ▶ Treble ▶ Balance ▶ Fader ▶ Volume

If you do not move to step 2 in five seconds, the unit will switch back to the volume adjustment mode (that is the normal mode).

NOTE Source tone memory

Each source (CD, FM, AM and disc changer) has its own memory in which to store the bass and treble tone settings. The settings made for a particular source are recalled automatically whenever you use that source (for example, FM mode uses the tone settings made for FM, AM for AM, etc.).

- 2 Press the \vee/\wedge buttons to adjust the mode shown in the display.
Use the following table as a guide for adjusting the settings in each mode.

Adjustment mode (Display)	Operation of Audio control button	
	\vee button	\wedge button
Bass ("BAS")	Bass decreased.	Bass increased.
Treble ("TRE")	Treble decreased.	Treble increased.
Balance ("BAL")	Left channel emphasized.	Right channel emphasized.
Fader ("FAD")	Rear channel increased.	Front channel increased.

Clock Display

Display the time.

Switching to Time Display:

Keep pressing the CLK button until the clock is displayed.

Adjusting Time

Adjust the time.

- 1 When the time is not displayed, first press the CLK button to display the time.
- 2 While holding down the CLK button, press the \lll or \ggg buttons to adjust the time.
The \lll button adjusts the hour and the \ggg button adjusts the minutes.

NOTE

Do not press the CLK button for two seconds or more, as it will change to the name preset mode.

Function of the KDC-4009

Selectable Illumination

You can switch the color of the button illumination between green and amber.

Switching the illumination:

Press the ILLUM button for at least one second to switch between amber and green.

Disabled System Indicator (DSI)

A red indicator will blink on the unit after the faceplate is removed, warning potential thieves. The factory default for this function is ON.

Turning Disabled System Indicator On/Off:

- 1 Turn the power of the unit off.
- 2 While pressing buttons #1 and #3 at the same time, press the TUN button.

Repeat steps 1 and 2 above to turn DSI back on.

Theft Deterrent Faceplate

The faceplate of the unit can be detached and taken with you, helping to deter theft.

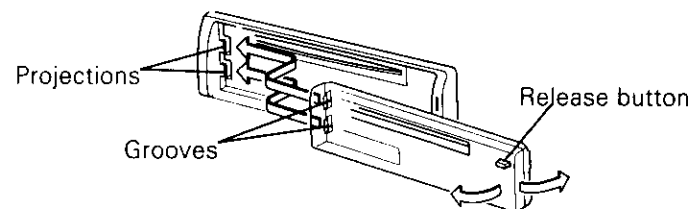
**Removing the Faceplate:**

Press the release button.
The faceplate is unlocked, allowing you to detach it.

NOTE

- The faceplate is a precision piece of equipment and can be damaged by shocks or jolts. For that reason, keep the faceplate in its special storage case while detached.

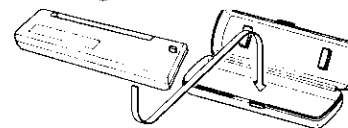





- Do not expose the faceplate or its storage case to direct sunlight or excessive heat or humidity. Also avoid places with too much dust or the possibility of water splashing.

Reattaching the Faceplate:

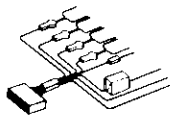
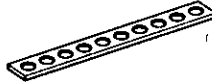
- 1 Align the projections on the unit with the grooves on the faceplate.
- 2 Push the faceplate in until it clicks.
The faceplate is locked in place, allowing you to use the unit.

Accessories

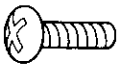
	External view	Number of items
①	1
②	1
③	2
④	1
⑤	4
⑥	4
⑦	 (KDC-4009/S3009 Only)1

▲CAUTION

Do not use any accessories other than those provided with your unit. If you use other accessories, you may damage the unit.

Installation Procedure

1. To prevent a short circuit, remove the key from the ignition and disconnect the ⊖ battery.
2. Make the proper input and output wire connections for each unit.
3. Connect the speaker wires of the wiring harness.
4. Connect the wiring harness wires in the following order: ground, battery, ignition.
5. Connect the wiring harness connector to the unit.
6. Install the unit in your car.
7. Reconnect the ⊖ battery.
8. Press the reset button.

▲CAUTION

- If your car's ignition does not have an ACC position, connect the ignition wires to a power source that can be turned on and off with the ignition key. If you connect the ignition wire to a power source with a constant voltage supply, as with battery wires, the battery may die.
- If the fuse blows, first make sure the wires aren't touching to cause a short circuit, then replace the old fuse with one with the same rating.
- Do not let unconnected wires or terminals touch metal on the car or anything else conducting electricity. To prevent a short circuit, do not remove the caps on the ends of the unconnected wires or the terminals.
- Connect the speaker wires correctly to the terminals to which they correspond. The unit may be damaged or fail to work if you share the ⊖ wires or ground them to any metal part in the car.
- After the unit is installed, check whether the brake lamps, blinkers, wipers, etc. on the car are working properly.
- Some disc changers need conversion cords for connection. See the section on "Safety Precautions" for details.
- Insulate unconnected wires with vinyl tape or other similar material.

Connecting Wires to Terminals

NOTE To connect the Disc changer, consult your Disc changer manual.
KENWOOD disc changer control input (KDC-4009 only)

If no connections are made, do not let the wire come out from the tab.

Connect either to the power control terminal when using the optional power amplifier, or to the antenna control terminal in the vehicle.

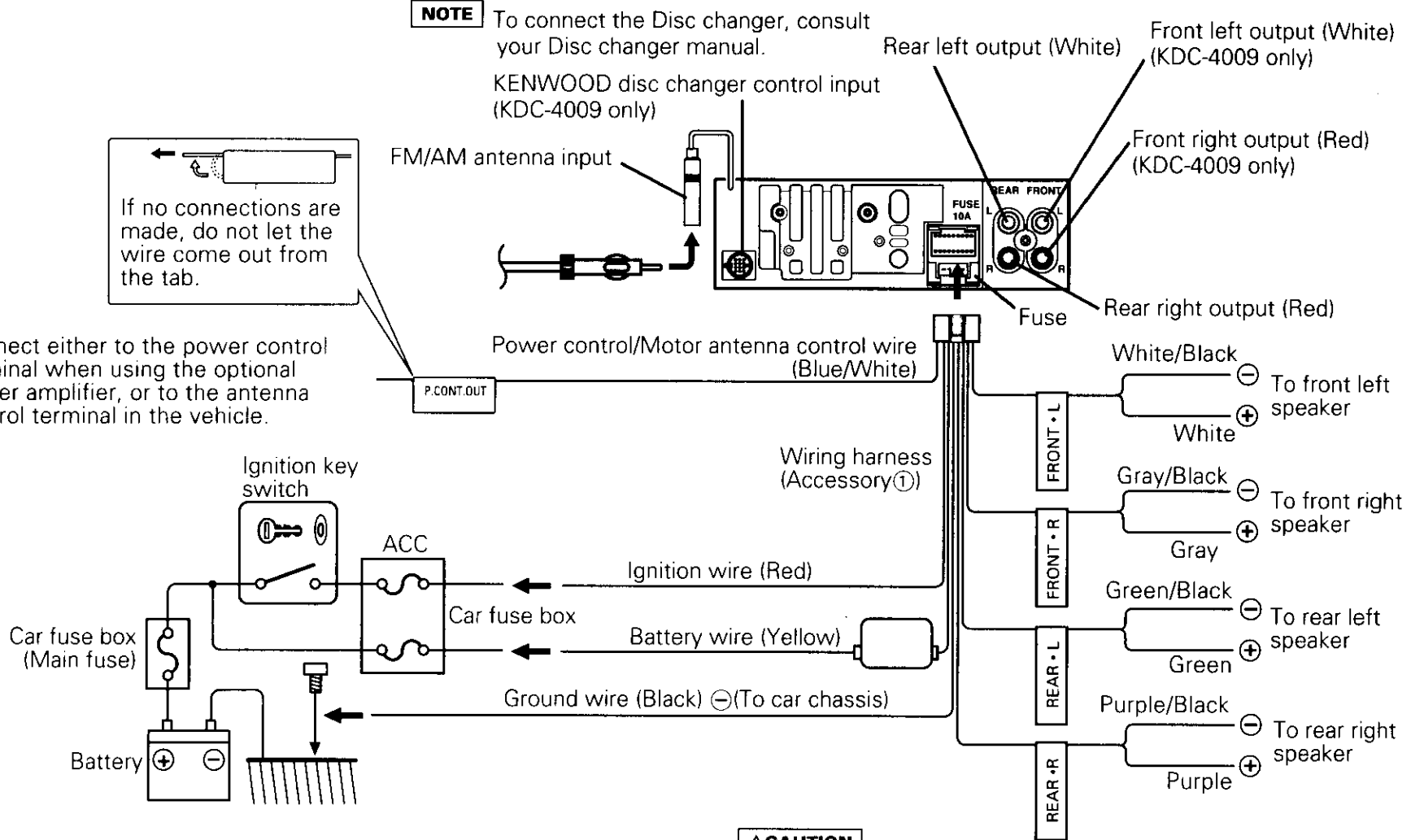

⚠ WARNING

If you connect the ignition wire (red) and the battery wire (yellow) to the car chassis (ground), you may cause a short circuit, that in turn may start a fire. Always connect those wires to the power source running through the fuse box.

⚠ CAUTION

When only two speakers are being connected to the system, connect the connectors either to both the front output terminals or to both the rear output terminals (do not mix front and rear). For example, if you connect the (+) connector of the left speaker to a front output terminal, do not connect the (-) connector to a rear output terminal.

Installation

■ Installation

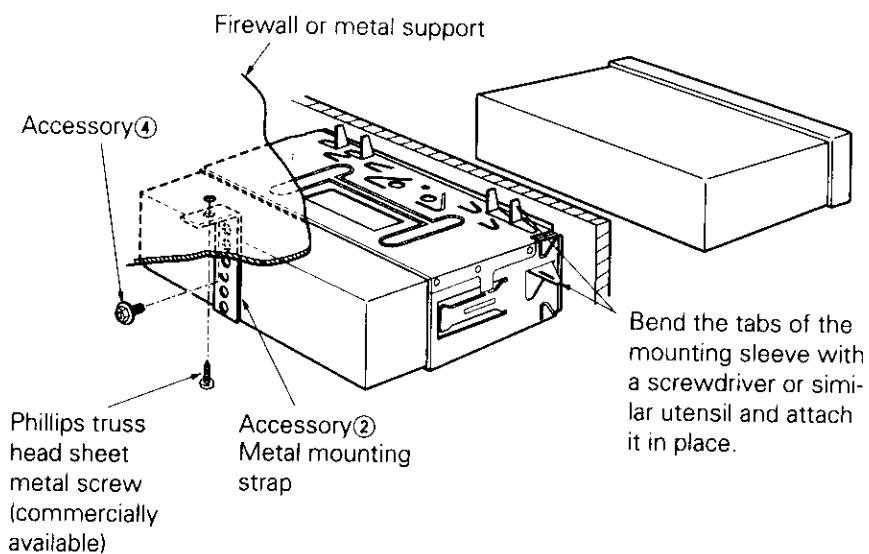

NOTE

Make sure that the unit is installed securely in place. If the unit is unstable, it may malfunction (for example, the sound may skip).

■ Installing in Japanese-Made Cars

- 1 Refer to the section "Removing the hard rubber frame" and then remove the hard rubber frame.
- 2 Align the holes in the unit (two locations on each side) with the vehicle mounting bracket and secure the unit with the accessory screws.

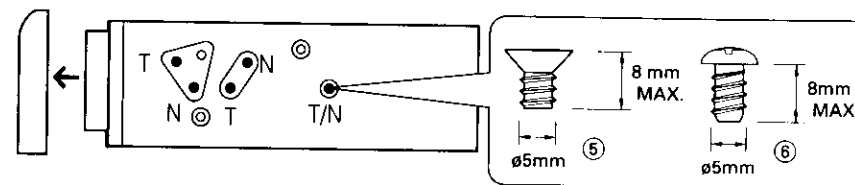

CAUTION

- Do not use your own screws. Use only the screws provided. If you use the wrong screws, you could damage the unit.
- Damage may occur if a screwdriver or similar tool is used with excessive force during the installations.

■ Removing the hard rubber frame

- 1 Engage the catch pins on the removal tool and remove the two locks on the lower level.
Lower the frame and pull it forward as shown in the figure.

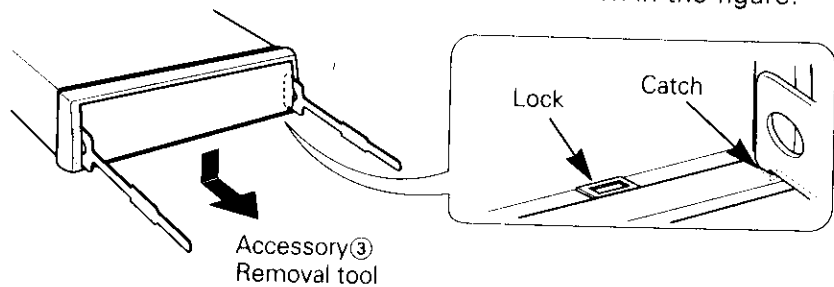

- 2 When the lower level is removed, remove the upper two locations.

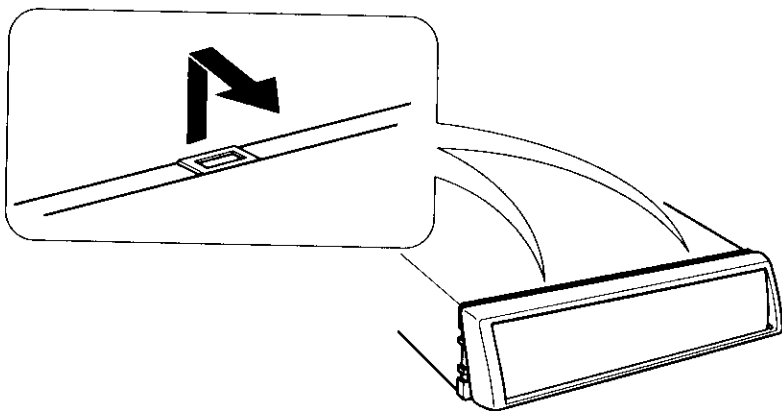

The frame can be removed from the top side in the same manner.

■ Removing the Unit

- 1 Refer to the section "Removing the hard rubber frame" and then remove the hard rubber frame.
- 2 Remove the hex head machine screw with washer (M4×8) on the back panel.
- 3 Insert the two removal tools deeply into the slots on each side, as shown.

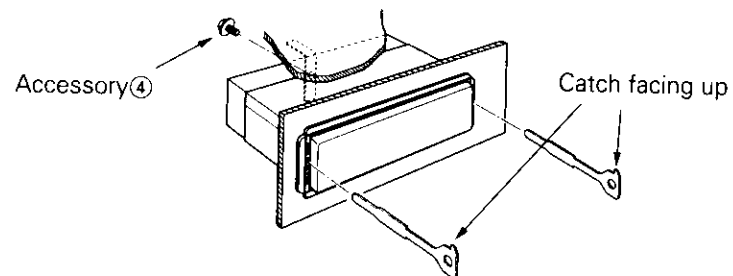

- 4 Lower the removal tool toward the bottom, and pull out the unit halfway while pressing towards the inside.

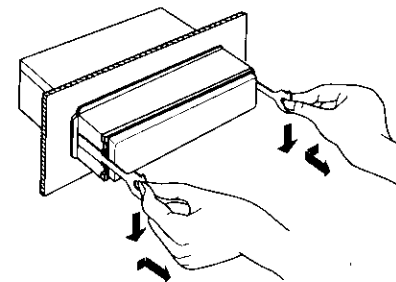

▲ CAUTION

Be careful to avoid injury from the catch pins on the removal tool.

- 5 Pull the unit all the way out with your hands, being careful not to drop it.

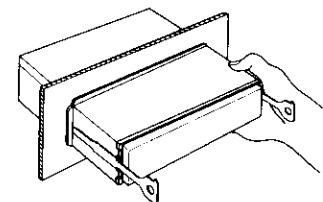

Installation

■ Screwing the Faceplate on the Unit

For KDC-4009/S3009

If you want to fasten the faceplate to the main unit so that it does not fall off, insert the provided screw ($\phi 4 \times 16\text{mm}$) in the hole shown below.

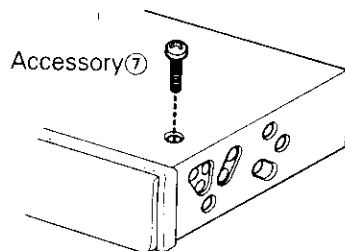

▲CAUTION

Never insert the phillips pan head screw ($\phi 4 \times 16\text{mm}$) in any other screw hole than the one specified. If you insert it in another hole, it will contact and may cause damage to the mechanical parts inside the unit.

Troubleshooting Guide

Disc Changer

PROBLEM	POSSIBLE CAUSE	SOLUTION
The disc changer mode cannot be selected.	No cable has been connected to the disc changer input terminal on the unit.	Connect the cable to the disc changer input terminal on the unit.
	The old/new selection switch of the disc changer is not set properly.	Set the old/new selection switch to "O" (old) position.
The specified disc does not play, but another one plays instead.	The specified CD is quite dirty.	Clean the CD.
	The CD is upside-down.	Load the CD with the labeled side up.
	The disc is loaded in a different slot from that specified.	Eject the disc magazine and check the number for the specified disc.
	The disc is severely scratched.	Try another disc instead.
The sound skips.	Something is touching the disc changer.	Remove whatever is touching it.
	The CD is scratched or dirty.	If skipping happens at the same place when the car is stopped, something with the CD is wrong. Clean the CD.
The display shows that the changer is being played, but no sound can be heard.	The computer chip in the unit is not functioning normally.	Press the reset button on the unit (see p.6).
The specified track will not play.	Random play or magazine random play has been selected.	Turn off random play or magazine random play.

The following messages are displayed when certain problems are occurring in your system. Take the recommended actions.

- EJECT** No disc magazine has been loaded in the changer. The disc magazine is not completely loaded.
⇒ Load the disc magazine properly.
- NO DISC** No disc has been loaded in the disc magazine.
⇒ Load a disc into the disc magazine.
- E-04** No disc has been loaded in the disc magazine.
⇒ Load a disc into the disc magazine.
The CD is quite dirty. The CD is upside-down. The CD is scratched a lot.
⇒ Clean the CD and load it correctly.
- BLANK** Nothing has been recorded on the MD.
⇒ The next MD will automatically be played.
- NO TRACK** No tracks are recorded on the MD, although it has a title.
⇒ The next MD will automatically be played.
- E-77** The unit is malfunctioning for some reason.
E-99 ⇒ Press the reset button on the unit. If the "E- 77", "E- 99" code does not disappear, consult your nearest service center.
- HOLD** The protective circuit in the unit activates when the temperature inside the automatic disc changer exceeds 60°C (140°F), stopping all operation.
⇒ Cool down the unit by opening the windows or turning on the air conditioner. As the temperature falls below 60°C (140°F), the disc will start playing again.

Specifications

Specifications subject to change without notice.

FM tuner section

Frequency range (200 kHz space)	87.9 MHz – 107.9 MHz
Usable sensitivity (S/N = 30dB)	9.3dBf (0.8 μ V/75 Ω)
Quieting Sensitivity (S/N = 50dB)	15.2dBf (1.6 μ V/75 Ω)
Frequency response (\pm 3.0 dB)	30 Hz – 15 kHz
Signal to Noise ratio (MONO)	70 dB
Selectivity (\pm 400 kHz)	\geq 80 dB
Image Response Ratio	70 dB
IF Response Ratio	120 dB
Stereo separation (1 kHz)	40 dB

AM tuner section

Frequency range (10 kHz space)	530 kHz – 1700 kHz
Usable sensitivity	28 dB (25 μ V)

CD player section

Laser diode	GaAlAs (λ =780 nm)
Digital filter (D/A)	8 Times Over Sampling
D/A Converter	1 Bit
Spindle speed	500 – 200 rpm (CLV)
Wow & Flutter	Below Measurable Limit
Frequency response (\pm 1 dB)	10 Hz – 20 kHz
Total harmonic distortion (1 kHz)	0.01 %
Signal to Noise ratio	93 dB (1kHz)
Dynamic range	93 dB
Channel separation	85 dB

Audio section

Maximum output power	35 W \times 4
Full bandwidth power (at less than 1% THD)	20 W \times 4
Tone action	
Bass:	100 Hz \pm 10 dB
Treble:	10 kHz \pm 10 dB
Preout level / Load	1800 mV/10 k Ω
Preout impedance	\leq 600 Ω

General

Operating voltage	14.4 V (11 – 16 V allowable)
Current consumption	10.0 A at Rated power
Installation size (W \times H \times D)	182 \times 53 \times 160 mm 7-3/16 \times 2-1/16 \times 6-5/16 in.
Weight	3.1 Lbs (1.4 kg)